



WYWIEW



NAWIEW



DTR

CE

PZH

## ZASTOSOWANIE

Wentylacja nawiewna lub wywiewna:

- magazynów, hal sklepowych i przemysłowych,
- budynków gospodarczych w rolnictwie, kuchni przemysłowych, etc.

## KONSTRUKCJA

- wentylator dachowy osiowy z wylotem poziomym,
- podstawa wykonana z galwanizowanej blachy stalowej,
- pokrywa wykonana z tłoczonej blachy aluminiowej,
- wirnik odlany w całości z tworzywa sztucznego wzmocnionego włóknem szklanym (modele od 315 do 400) lub składany z łopatek z tworzywa macowanych na płacie aluminiowej (modele od 450 do 1000),
- temperatura pracy od  $-40^{\circ}\text{C}$  do  $+70^{\circ}\text{C}$  ( $-30^{\circ}\text{C}$  do  $+40^{\circ}\text{C}$  dla modeli 800-1000),
- dostępny w dwóch wersjach: nawiewnej "A" i wywiewnej "B".

Wersje przeciwybuchowe zgodne z dyrektywą ATEX dostępne na życzenie:

- silnik budowy wzmocnionej: II 2G Exe II T3,
- silnik budowy ognioszczelnej: II 2G Exd IIB T5 lub II 2G Exd IIC T4 (tylko dla modeli 800, 900, 1000 z silnikami 4- lub 6-biegunowymi),
- do pracy w strefie 22: II 3D Ex tc IIIB T125°C.

## SILNIK ELEKTRYCZNY

- asynchroniczny jednofazowy 230V, 50Hz,
- asynchroniczny trójfazowy 400V, 50Hz,
- klasa izolacji F, IP65 (z wyjątkiem modeli 800 do 1000 - IP55),
- termiczne zabezpieczenie przed przeciążeniem (z wyjątkiem modeli 800 do 1000),
- silniki jednofazowe przystosowane do napięciowej regulacji prędkości obrotowej (z wyjątkiem modeli HCTB/4-560, HCTB/4-630),
- silniki trójfazowe mogą być przełączane Y/D przy zasilaniu 380-415V, 50Hz,
- silniki trójfazowe jednobiegowe przystosowane do regulacji falownikiem oraz regulatorem transformatorowym (z wyjątkiem HCTT/4-560, HCTT/4-630 oraz Ø710 do Ø1000).

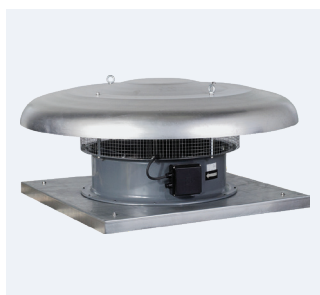

Wersja do stref zagrożenia wybuchem HCTT EX



Ułatwiony montaż na dachu

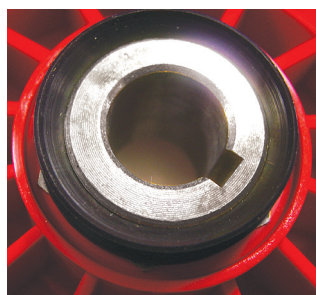

Stalowa tuleja wysokiej jakości



Wirnik wyważony dynamicznie zgodnie z ISO 1940

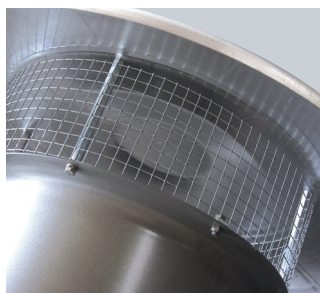

Siatka ochronna

## DANE TECHNICZNE DLA WENTYLATORÓW WYWIEWNYCH (TYP B)

Typ	predkość obrotowa	pobór mocy max	natężenie 230V   400V		wydajność max		poziom ciśn. akust.* wlot   wylot		masa	regulator	nr artykułu
					wyższa predkość	wyższa predkość					
	[obr/min]	[W]	[A]	[m³/h]	[m³/h]	[dB(A)]	[kg]				
<b>JEDNOFAZOWE 4 BIEGUNOWE</b>											
HCTB/4-315-B	1300	100	0,59	-	1930	-	59	58	14,4	TLR 15 DS/RVS-1,5	43525620
HCTB/4-355-B	1225	200	0,96	-	2680	-	56	55	15,8	TLR 15 DS/RVS-1,5	43525630
HCTB/4-400-B	1290	340	1,64	-	3700	-	59	58	16,5	TLR 25 DS/RVS-3	43525640
HCTB/4-450-B	1290	480	2,3	-	5600	-	62	61	23,5	TLR 25 DS/RVS-3	43525650
HCTB/4-500-B	1290	650	3	-	7100	-	69	67	25,4	REB-5/RVS-3	43525660
HCTB/4-560-B	1200	980	4,9	-	9820	-	73	69	40	-	43525670
HCTB/4-630-B	1290	1700	7,6	-	13000	-	74	70	42,6	-	43525680
<b>JEDNOFAZOWE 6 BIEGUNOWE</b>											
HCTB/6-450-B	835	220	1,15	-	3900	-	53	52	23,5	TLR 15 DS/RVS-1,5	43525690
HCTB/6-500-B	840	290	1,6	-	4600	-	56	54	25,4	TLR 25 DS/RVS-3	43525700
HCTB/6-560-B	900	420	2,4	-	6850	-	60	58	40	TLR 25 DS/RVS-3	43525710
HCTB/6-630-B	800	510	2,56	-	8400	-	64	61	42,6	REB-5/RVS-3	43525720
<b>TRÓJFAZOWE 4 BIEGUNOWE</b>											
HCTT/4-315-B	1300	150	-	0,34	1930	1500	59	58	14,4	RMT-1,5/Falownik 0,4 kW	43525730
HCTT/4-355-B	1260	200	-	0,46	2680	2000	56	55	15,8	RMT-1,5/Falownik 0,4 kW	43525740
HCTT/4-400-B	1350	300	-	0,8	3700	2900	59	58	16,5	RMT-1,5/Falownik 0,4 kW	43525750
HCTT/4-450-B	1230	500	-	1	5600	4500	63	61	23,5	RMT-1,5/Falownik 0,4 kW	43525760
HCTT/4-500-B	1350	660	-	1,6	7100	5850	69	67	25,4	RMT-2,5/Falownik 0,75kW	43525770
HCTT/4-560-B	1320	1210	-	2,3	9820	7600	73	69	40	Falownik 0,75 kW	43525780
HCTT/4-630-B	1290	1600	-	3,2	13000	-	74	70	42,6	Falownik 1,5 kW	43525790
HCTT/4-710-B	1300	2200	-	4	18400	-	82	80	60	Falownik 2,2 kW	43525800
HCTT/4-800-B	1400	3 kW	-	7,3	23800	-	89	86	57	Falownik 4 kW	43525810
HCTT/4-900-B	1400	4 kW	-	9,5	30000	-	92	89	77	Falownik 5,5 kW	43525820
HCTT/4-1000-B	1450	5,5 kW	-	12	38500	-	93	90	123	Falownik 5,5 kW	43525610
<b>TRÓJFAZOWE 6 BIEGUNOWE</b>											
HCTT/6-450-B	835	190	-	0,48	3900	3000	53	52	23,5	RMT-1,5/Falownik 0,4 kW	43525830
HCTT/6-500-B	830	250	-	0,57	4600	3500	56	54	25,4	RMT-1,5/Falownik 0,4 kW	43525840
HCTT/6-560-B	850	410	-	0,93	6850	5400	60	58	40	RMT-1,5/Falownik 0,4 kW	43525850
HCTT/6-630-B	810	600	-	1,18	8400	6400	64	61	42,6	RMT-1,5/Falownik 0,75 kW	43525860
HCTT/6-710-B	900	1100	-	3,3	12700	-	72	70	54	RMT-5/Falownik 1,5 kW	43525870
HCTT/6-800-B	930	0,75 kW	-	2,5	15800	-	79	76	57	-	43525880
HCTT/6-900-B	930	1,1 kW	-	3,5	20000	-	82	79	67	-	43525890
HCTT/6-1000-B	930	1,5 kW	-	4,5	24700	-	83	80	108	-	43525900
<b>TRÓJFAZOWE 8 BIEGUNOWE</b>											
HCTT/8-710-B	670	370	-	1,2	9500	-	64	62	52	Falownik 0,4 kW	43525910
HCTT/8-800-B	700	0,37 kW	-	1,9	11900	-	71	68	57	Falownik 0,75 kW	43525920
HCTT/8-900-B	700	0,55 kW	-	2,3	15000	-	74	71	67	Falownik 0,75 kW	43525930
HCTT/8-1000-B	700	0,75 kW	-	2,8	18600	-	75	72	108	Falownik 1,5 kW	43525940

\* Mierzony w wolnej przestrzeni z odległości 1,5 m.

## DANE TECHNICZNE DLA WENTYLATORÓW NAWIEWNYCH (TYP A)

Typ	predkość obrotowa	pobór mocy max	natężenie 230V   400V		wydajność max		poziom ciśn. akust.* wlot   wylot		masa	regulator	nr artykułu
					wyższa predkość	wyższa predkość					
	[obr/min]	[W]	[A]	[m³/h]	[m³/h]	[dB(A)]	[kg]				
<b>JEDNOFAZOWE 4 BIEGUNOWE</b>											
HCTB/4-315-A	1300	100	0,54	-	2150	-	58	64	14,4	TLR 15 DS/RVS-1,5	43525620-01
HCTB/4-355-A	1225	200	0,96	-	3250	-	59	61	15,8	TLR 15 DS/RVS-1,5	43525630-01
HCTB/4-400-A	1200	340	1,64	-	4720	-	64	68	16,5	TLR 25 DS/RVS-3	43525640-01
HCTB/4-450-A	1290	480	2,3	-	6670	-	68	73	23,5	TLR 25 DS/RVS-3	43525650-01
HCTB/4-500-A	1290	650	3,1	-	8440	-	72	76	25,4	REB-5/RVS-5	43525660-01
HCTB/4-560-A	1250	980	4,9	-	11400	-	75	80	40	-	43525670-01
HCTB/4-630-A	1200	1700	7,6	-	15300	-	79	84	42,6	-	43525680-01
<b>JEDNOFAZOWE 6 BIEGUNOWE</b>											
HCTB/6-450-A	835	220	1,1	-	4400	-	56	60	23,5	TLR 15 DS/RVS-1,5	43525690-01
HCTB/6-500-A	840	290	1,5	-	5500	-	60	63	25,4	TLR 15 DS/RVS-1,5	43525700-01
HCTB/6-560-A	900	420	2,3	-	7900	-	64	68	40	TLR 25 DS/RVS-3	43525710-01
HCTB/6-630-A	900	510	2,5	-	9900	-	66	70	42,6	TLR 25 DS/RVS-3	43525720-01
<b>TRÓJFAZOWE 4 BIEGUNOWE</b>											
HCTT/4-315-A	1360	150	-	0,34	2150	1820	58	64	14,4	RMT-1,5/Falownik 0,4 kW	43525730-01
HCTT/4-355-A	1350	200	-	0,46	3250	2520	59	61	15,8	RMT-1,5/Falownik 0,4 kW	43525740-01
HCTT/4-400-A	1380	300	-	0,8	4720	3900	64	68	16,5	RMT-1,5/Falownik 0,4 kW	43525750-01
HCTT/4-450-A	1350	500	-	0,95	6670	5250	68	71	23,5	RMT-1,5/Falownik 0,4 kW	43525760-01
HCTT/4-500-A	1380	660	-	1,6	8440	7000	72	76	25,4	RMT-2,5/Falownik 0,75kW	43525770-01
HCTT/4-560-A	1380	1210	-	2,3	11400	9800	75	80	40	Falownik 0,75 kW	43525780-01
HCTT/4-630-A	1360	1600	-	3	15300	-	79	84	42,6	Falownik 1,5 kW	43525790-01
HCTT/4-710-A	1300	2200	-	4	20500	-	80	85	60	Falownik 2,2 kW	43525800-01
HCTT/4-800-A	1400	3 kW **	-	7,3	26600	-	85	90	67	Falownik 4 kW	43525810-01
HCTT/4-900-A	1400	4 kW **	-	9,5	35900	-	88	94	77	Falownik 5,5 kW	43525820-01
HCTT/4-1000-A	1400	5,5 kW **	-	12	44900	-	89	95	123	Falownik 5,5 kW	43525610-01
<b>TRÓJFAZOWE 6 BIEGUNOWE</b>											
HCTT/6-450-A	835	190	-	0,48	4400	3600	56	60	23,5	RMT-1,5/Falownik 0,4 kW	43525830-01
HCTT/6-500-A	830	250	-	0,57	5500	4500	60	63	25,4	RMT-1,5/Falownik 0,4 kW	43525840-01
HCTT/6-560-A	850	410	-	0,93	7900	6700	64	68	40	RMT-1,5/Falownik 0,4 kW	43525850-01
HCTT/6-630-A	810	600	-	1,18	9900	7800	66	70	42,6	RMT-1,5/Falownik 0,75 kW	43525860-01
HCTT/6-710-A	900	1100	-	3,3	14200	-	69	75	54	Falownik 1,5 kW	43525870-01
HCTT/6-800-A	930	0,75 kW **	-	2,5	17700	-	75	80	57	-	43525880-01
HCTT/6-900-A	930	1,1 kW **	-	3,5	23800	-	78	84	67	-	43525890-01
HCTT/6-1000-A	930	1,5 kW **	-	4,5	28800	-	79	85	108	-	43525900-01
<b>TRÓJFAZOWE 8 BIEGUNOWE</b>											
HCTT/8-710-A	670	370	1,2	10,600	-	61	67	52	52	Falownik 0,4 kW	43525910-01
HCTT/8-800-A	700	0,37 kW **	-	1,9	13300	-	67	72	57	Falownik 0,75 kW	43525920-01
HCTT/8-900-A	700	0,55 kW **	-	2,3	18000	-	70	76	67	Falownik 0,75 kW	43525930-01
HCTT/8-1000-A	700	0,75 kW **	-	2,8	21700	-	71	77	108	Falownik 1,5 kW	43525940-01

\* Mierzony w wolnej przestrzeni z odległości 1,5 m

\*\* Moc nominalna

## CHARAKTERYSTYKI PRACY - WYWIEW (TYP B)

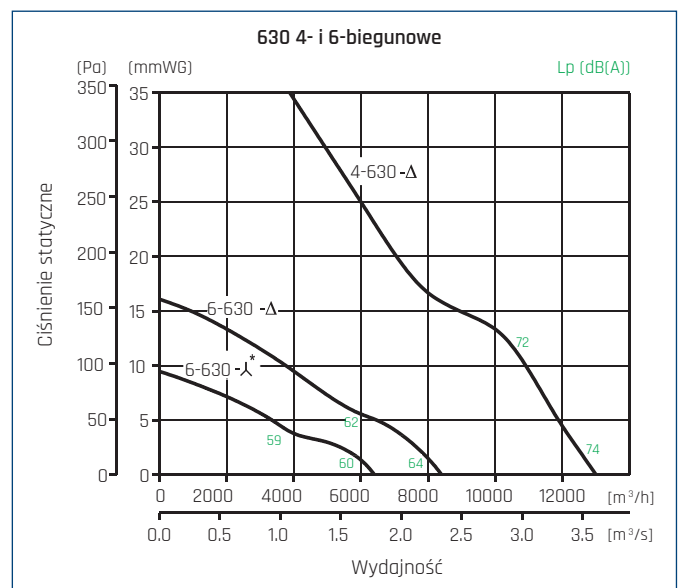
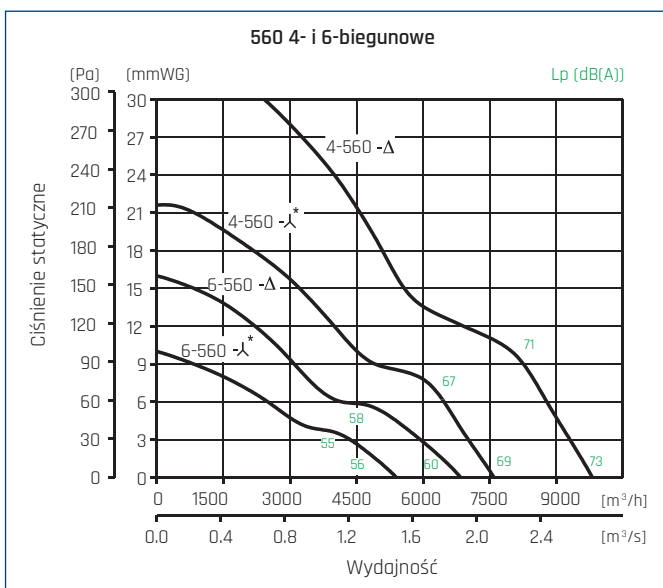
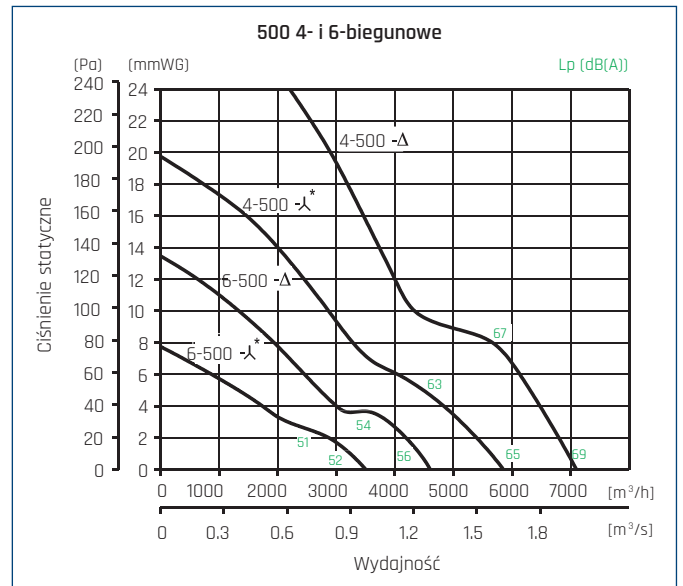
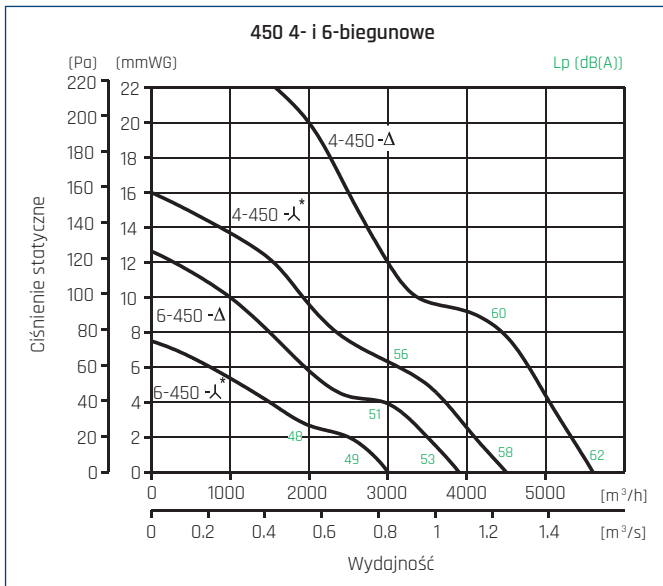
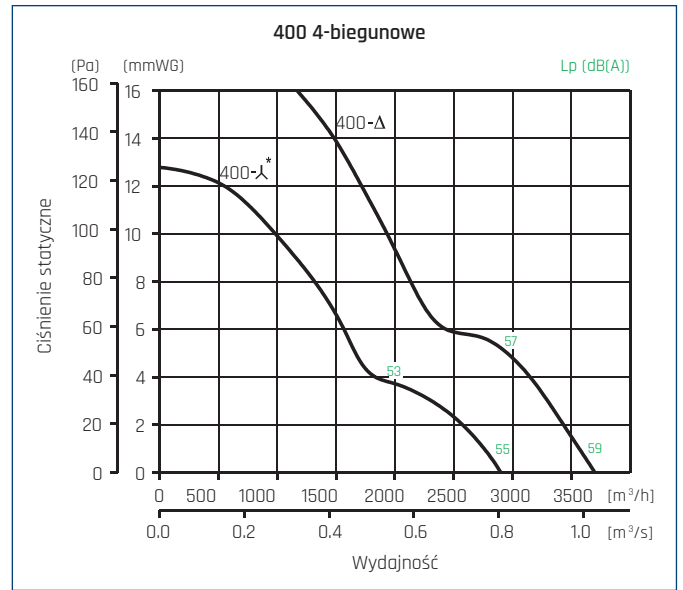
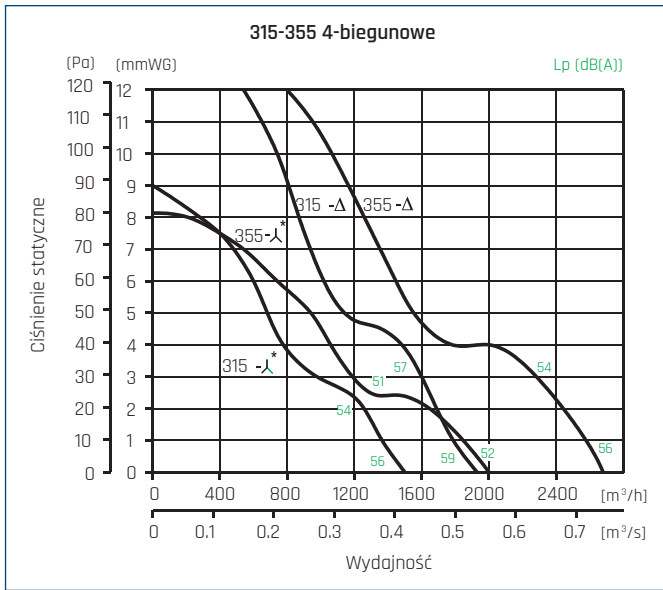

\* niższy bieg (λ) tylko dla wersji trójfazowej

## CHARAKTERYSTYKI PRACY - WYWIEW (TYP B)

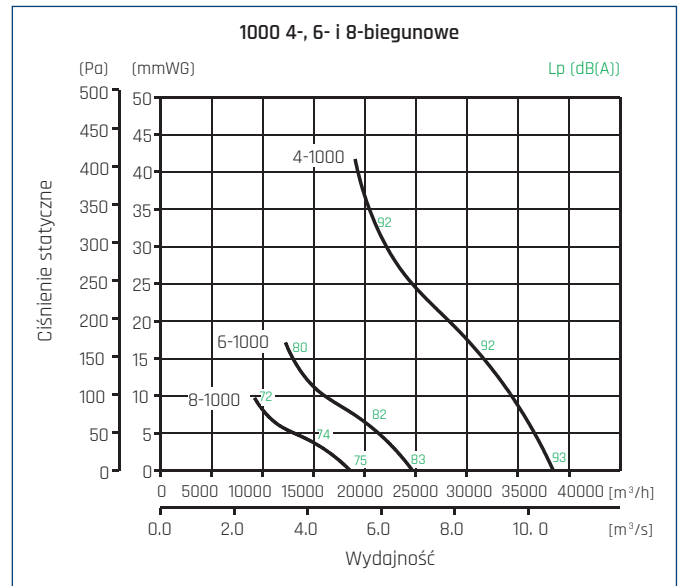
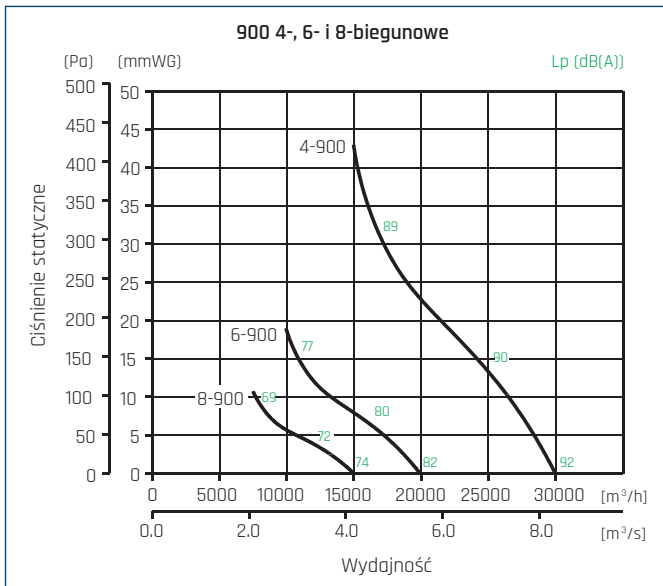
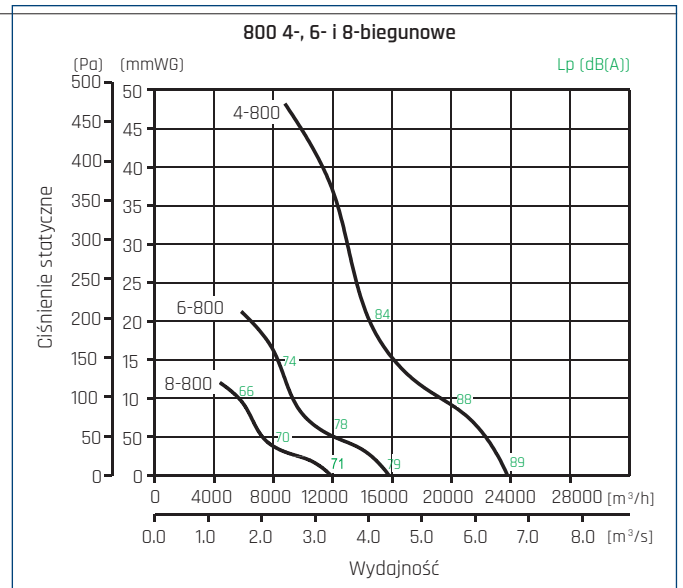
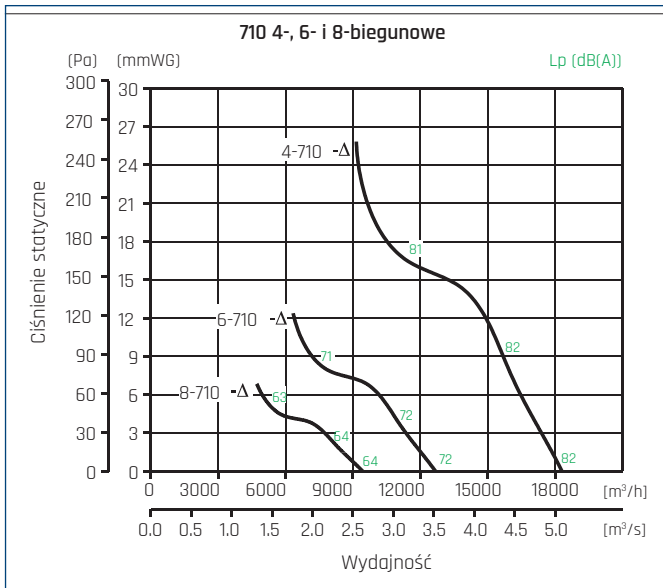

\* niższy bieg (Δ) tylko dla wersji trójfazowej

## CHARAKTERYSTYKI PRACY - NAWIEW (TYP A)

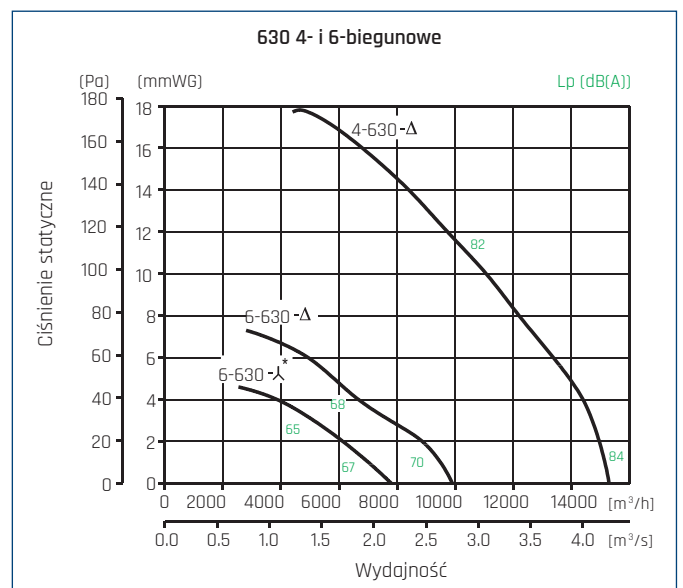
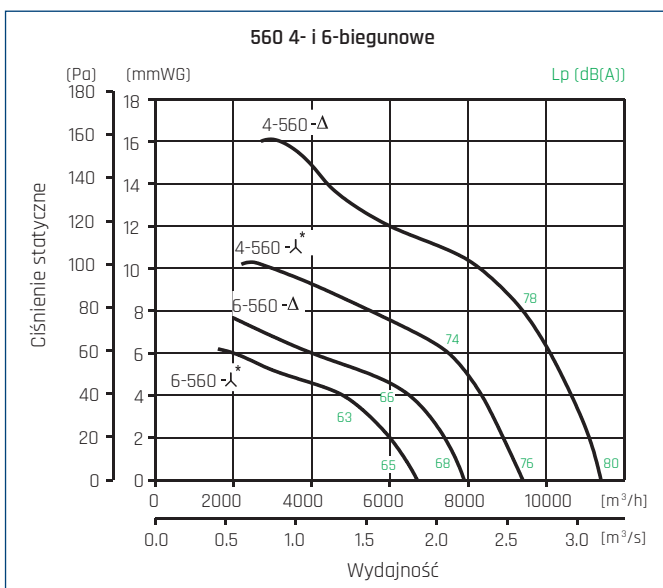
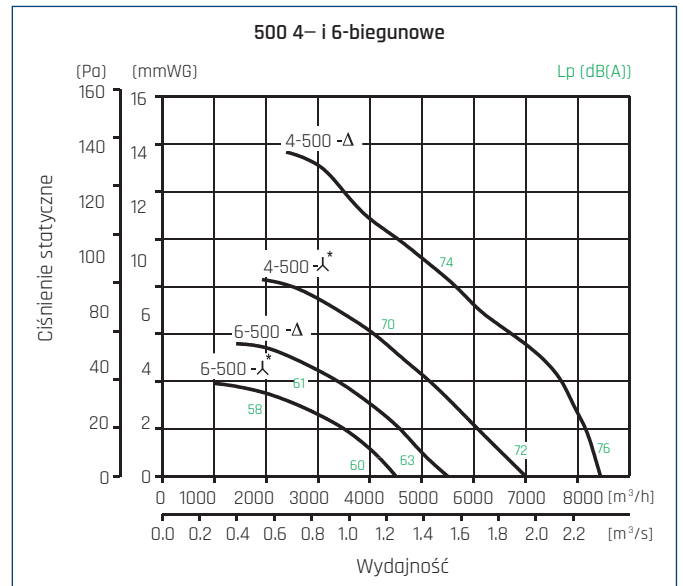
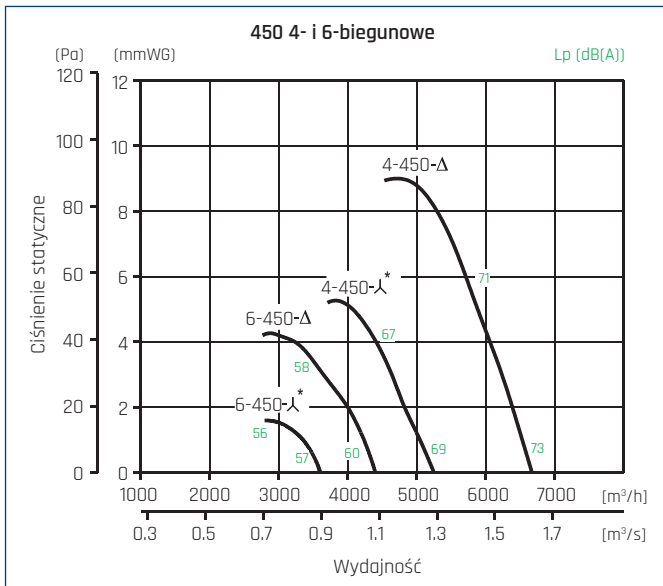
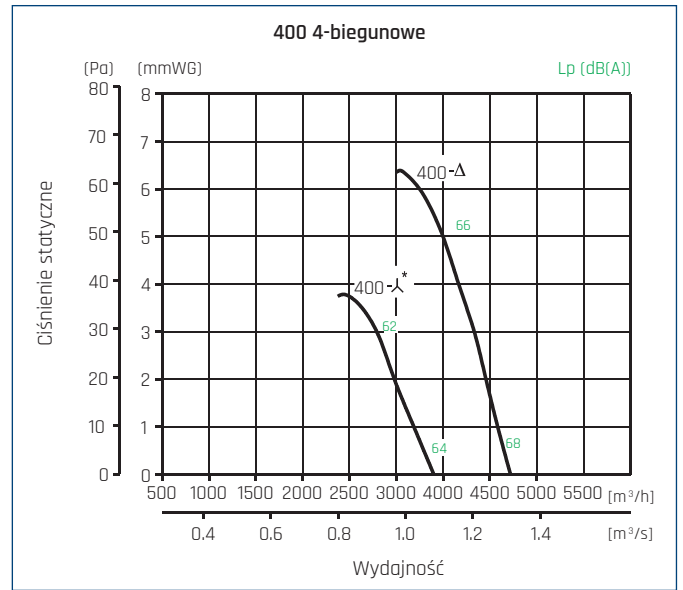
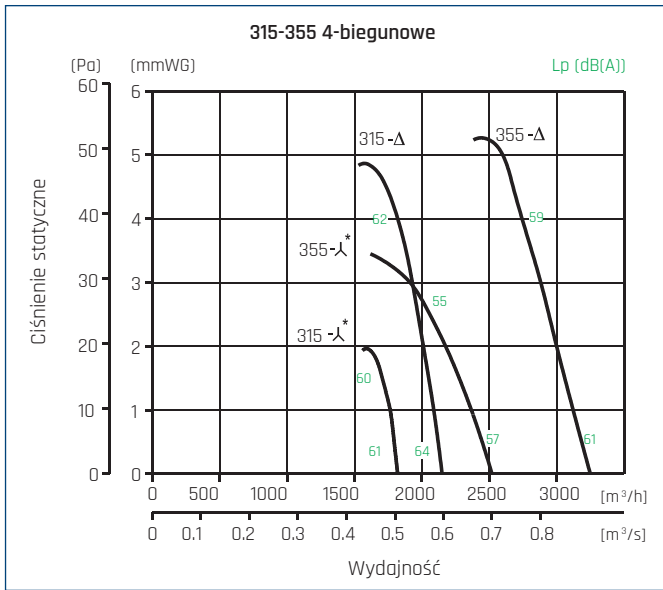

\* niższy bieg (λ) tylko dla wersji trójfazowej

## CHARAKTERYSTYKI PRACY - NAWIEW (TYP A)

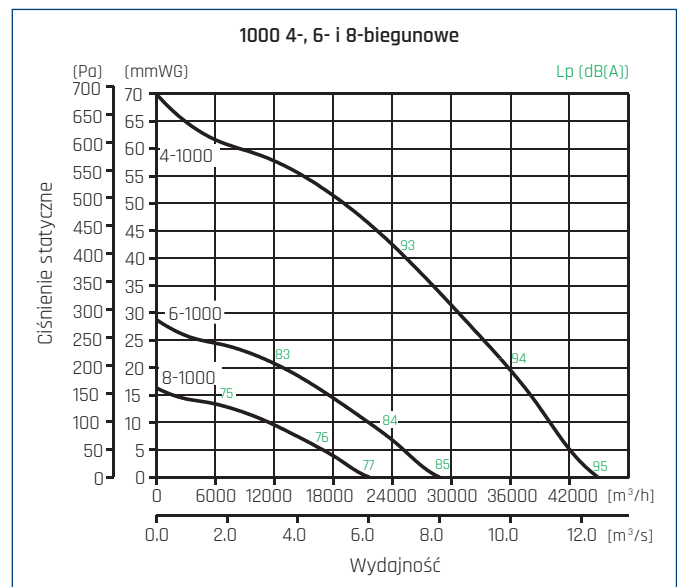
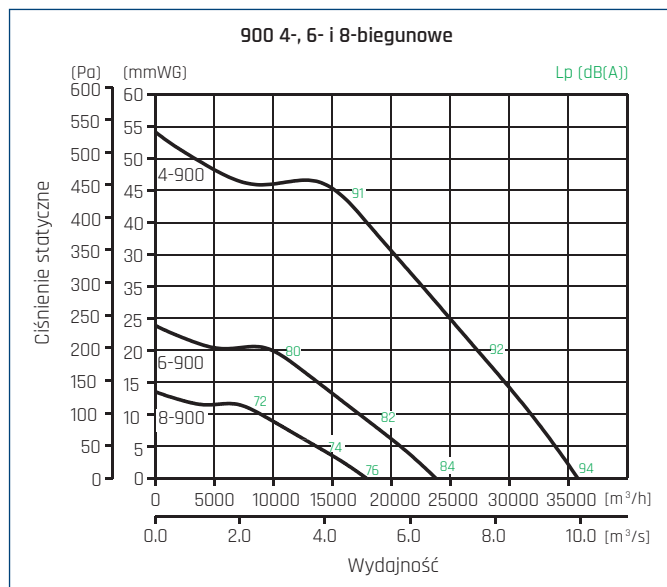
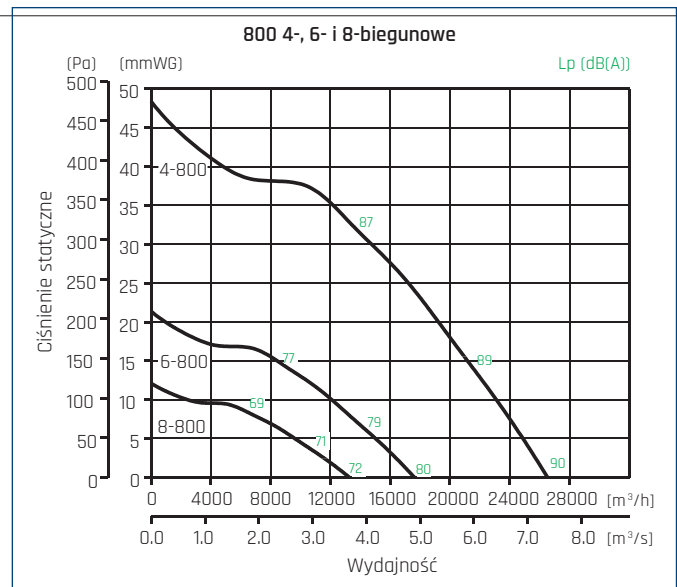
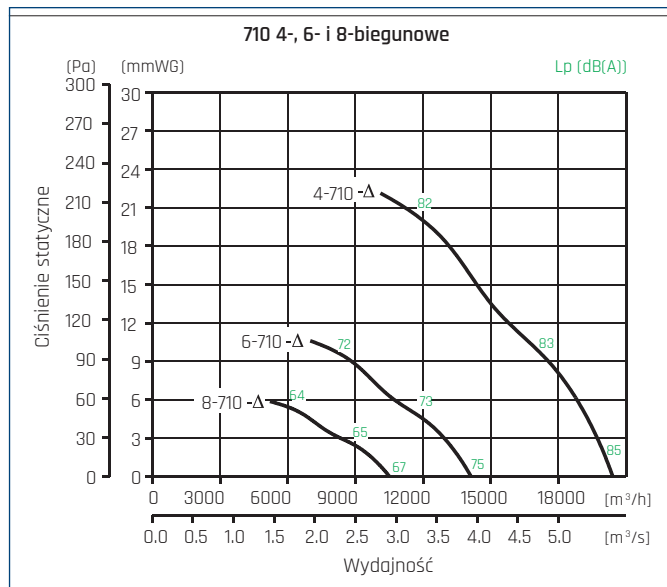

\* niższy bieg (λ) tylko dla wersji trójfazowej

## WYMIARY [mm]

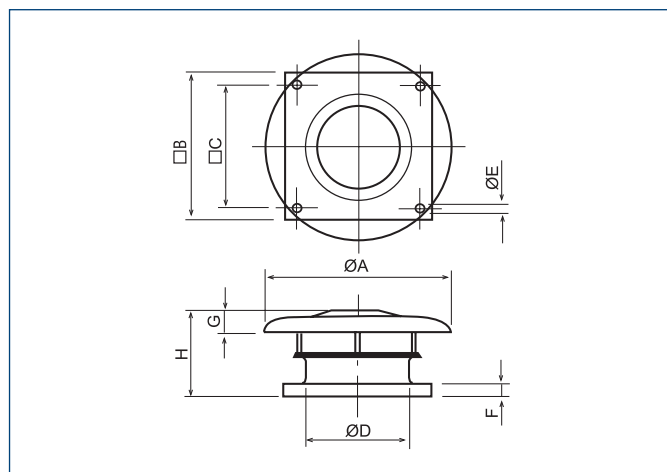

Typ	ØA	ØB	ØC	ØD	ØE	F	G	H
315	640	560	450	315	12	40	70	341
355	760	630	535	355	12	40	80	361
400	760	630	535	400	12	40	80	361
450	895	710	590	450	14	40	110	410
500	895	710	590	500	14	40	110	410
560	1150	905	750	560	14	50	165	488
630	1150	905	750	630	14	50	165	488
710	1350	1100	840	710	14	50	200	551
800	1350	1100	840	800	14	50	200	732
900	1580	1250	950	900	14	50	200	756
1000	1580	1250	950	1000	14	50	200	756

## CHARAKTERYSTYKA AKUSTYCZNA

Wywiew			63	125	250	500	1000	2000	4000	8000
4-biegunowe	315	Wlot	41	57	51	73	64	63	58	51
		Wylot	41	53	54	72	62	60	56	50
	355	Wlot	45	56	56	60	65	66	63	56
		Wylot	46	56	63	61	63	64	61	54
	400	Wlot	50	59	58	65	66	69	68	59
		Wylot	51	60	63	65	65	66	66	57
	450	Wlot	52	60	60	67	72	71	69	61
		Wylot	52	63	64	68	70	70	68	61
	500	Wlot	55	64	71	74	80	79	74	66
		Wylot	55	65	72	74	76	75	71	64
	560	Wlot	57	65	75	81	82	81	76	69
		Wylot	57	69	73	76	78	78	75	67
	630	Wlot	63	70	72	79	83	83	81	73
		Wylot	62	73	75	77	80	78	76	71
	710	Wlot	71	82	90	89	93	89	82	73
		Wylot	72	86	89	87	89	86	80	72
	800	Wlot	76	91	96	99	99	95	87	79
		Wylot	77	93	95	94	94	92	86	77
	900	Wlot	77	94	98	102	102	98	91	83
		Wylot	77	96	98	97	97	95	89	80
1000	Wlot	76	93	97	103	103	101	94	86	
	Wylot	78	94	96	97	100	99	93	85	

Nawiew			63	125	250	500	1000	2000	4000	8000
4-biegunowe	315	Wlot	39	61	62	77	68	66	58	52
		Wylot	38	59	65	69	65	60	55	50
	355	Wlot	41	61	64	69	72	71	64	56
		Wylot	40	62	66	67	69	66	61	52
	400	Wlot	47	67	71	75	78	76	69	59
		Wylot	46	66	68	72	74	71	65	54
	450	Wlot	50	71	75	79	82	79	72	64
		Wylot	47	72	72	77	78	73	67	59
	500	Wlot	57	75	80	84	86	83	76	68
		Wylot	55	74	79	81	82	78	71	65
	560	Wlot	58	85	84	87	90	87	79	71
		Wylot	58	80	84	82	85	82	75	66
	630	Wlot	63	86	90	91	94	91	83	73
		Wylot	64	83	89	87	88	85	77	68
	710	Wlot	73	89	92	93	96	92	84	76
		Wylot	71	88	89	87	88	85	78	70
	800	Wlot	73	89	95	100	100	97	91	84
		Wylot	70	91	94	94	93	90	83	75
	900	Wlot	85	93	99	104	104	101	95	88
		Wylot	73	95	97	97	96	94	88	80
1000	Wlot	78	92	99	104	105	104	98	90	
	Wylot	72	94	95	97	99	97	91	83	

Wywiew			63	125	250	500	1000	2000	4000	8000
6-biegunowe	450	Wlot	42	48	54	58	62	64	58	50
		Wylot	44	50	56	58	60	61	57	49
	500	Wlot	45	52	57	60	65	66	62	53
		Wylot	46	53	59	61	63	63	59	52
	560	Wlot	48	56	62	64	70	70	65	57
		Wylot	49	59	63	64	66	67	63	55
	630	Wlot	51	57	65	68	73	74	70	60
		Wylot	53	61	66	67	69	70	68	59
	710	Wlot	61	72	80	79	83	79	72	63
		Wylot	62	76	79	77	79	76	70	62
	800	Wlot	66	81	86	89	89	85	77	69
		Wylot	67	83	85	84	84	82	76	67
	900	Wlot	67	84	88	92	92	88	81	73
		Wylot	67	86	88	87	87	85	79	70
	1000	Wlot	66	83	87	93	93	91	84	76
		Wylot	68	84	86	87	90	89	83	75

Nawiew			63	125	250	500	1000	2000	4000	8000
6-biegunowe	450	Wlot	49	60	65	67	70	67	60	52
		Wylot	44	58	66	65	65	62	55	47
	500	Wlot	54	65	69	71	74	71	62	54
		Wylot	52	63	68	69	69	66	59	50
	560	Wlot	56	70	74	75	78	75	67	59
		Wylot	54	70	72	71	73	70	63	54
	630	Wlot	59	73	78	77	80	77	68	59
		Wylot	57	72	76	73	75	72	64	54
	710	Wlot	63	79	82	83	86	82	74	66
		Wylot	60	77	78	76	77	74	67	59
	800	Wlot	63	79	85	90	90	87	81	74
		Wylot	60	81	84	84	83	80	73	65
	900	Wlot	75	83	89	94	94	91	85	78
		Wylot	63	85	87	87	86	84	78	70
	1000	Wlot	68	82	89	94	95	94	88	80
		Wylot	62	84	85	87	89	87	81	73

Wywiew			63	125	250	500	1000	2000	4000	8000
8-biegunowe	710	Wlot	53	64	72	71	75	71	64	55
		Wylot	54	68	71	69	71	68	62	54
	800	Wlot	58	73	78	81	81	77	69	61
		Wylot	59	75	77	76	76	74	68	59
	900	Wlot	59	76	80	84	84	80	73	65
		Wylot	59	78	80	79	79	77	71	62
	1000	Wlot	58	75	79	85	85	83	76	68
		Wylot	60	76	78	79	82	81	75	67

Nawiew			63	125	250	500	1000	2000	4000	8000
8-biegunowe	710	Wlot	55	71	74	75	78	74	66	58
		Wylot	52	69	70	68	69	66	59	51
	800	Wlot	55	71	77	82	82	79	73	66
		Wylot	52	73	76	76	75	72	65	57
	900	Wlot	67	75	81	86	86	83	77	70
		Wylot	55	77	79	79	78	76	70	62
	1000	Wlot	60	74	81	86	87	86	80	72
		Wylot	54	76	77	79	81	79	73	65



## AKCESORIA MONTAŻOWE

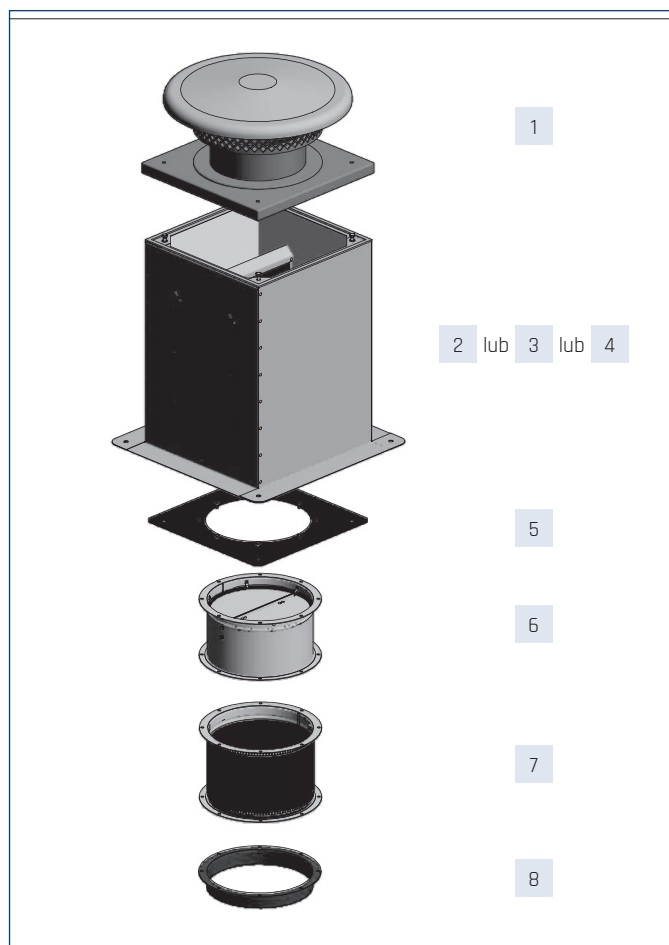

1	2	3	4	5
Wentylator	podstawa dachowa krótka	podstawa dachowa	podstawa dachowa tłumiąca	złącze
315	RSS 560	RS 560	RSA 560	P 560
355	RSS 630	RS 630	RSA 630	P 630
400	RSS 630	RS 630	RSA 630	P 630
450	RSS 710	RS 710	RSA 710	P 710
500	RSS 710	RS 710	RSA 710	P 710
560	RSS 905	RS 905	RSA 905	P 905
630	RSS 905	RS 905	RSA 905	P 905
710	RSS 1100	RS 1100	RSA 1100	P 1100
800	RSS 1100	RS 1100	RSA 1100	P 1100
900	-	RS 1250	RSA 1250	P 1250
1000	-	RS 1250	RSA 1250	P 1250

1	6	7	8
Wentylator	klapa zwrotna	złącze przeciwdrganiowe	króciec
315	KZD 560	ZPD 560	K 560
355	KZD 630	ZPD 630	K 630
400	KZD 630	ZPD 630	K 630
450	KZD 710	ZPD 710	K 710
500	KZD 710	ZPD 710	K 710
560	KZD 905	ZPD 905	K 905
630	KZD 905	ZPD 905	K 905
710	KZD 1100	ZPD 1100	K 1100
800	KZD 1100	ZPD 1100	K 1100
900	KZD 1250	ZPD 1250	K 1250
1000	KZD 1250	ZPD 1250	K 1250

### Numery artykułów

K 1100	43526460	KZD 560	43527320	P 710	43526340	RSA 1100	43526170	RSS 630	43526540
K 1250	43526470	KZD 630	43527330	P 905	43526350	RSA 1250	43526180	RSS 710	43526550
K 560	43526420	KZD 710	43527340	RS 1100	43526070	RSA 560	43526130	RSS 905	43526560
K 630	43526430	KZD 905	43527350	RS 1250	43526080	RSA 630	43526140	ZPD 1100	43527460
K 710	43526440	P 1100	43526360	RS 560	43526030	RSA 710	43526150	ZPD 560	43527420
K 905	43526450	P 1250	43526370	RS 630	43526040	RSA 905	43526160	ZPD 630	43527430
KZD 1100	43527360	P 560	43526320	RS 710	43526050	RSS 1100	43526570	ZPD 710	43527440
KZD 1250	43527370	P 630	43526330	RS 905	43526060	RSS 560	43526530	ZPD 905	43527450

podstawa dachowa RS str. 522	podstawa tłumiąca RSA str. 523	podstawa dachowa RSS str. 524	złącze P str. 525	klapa zwrotna KZD str. 525	złącze p-drg. ZPD str. 526	króciec K str. 526

## AKCESORIA ELEKTRYCZNE

Wentylator	termostat ścienny	termostat kanałowy	czujnik zanieczyszczeń	higrostat	regulator tyrystorowy		
	TS	TK-1	SQA	HIG-2	REB N	REB NE	TLR
HCTB/4-315	TS	TK-1	SQA	HIG-2	REB-1 N	REB-1 NE	TLR 15 DS
HCTB/4-355	TS	TK-1	SQA	HIG-2	REB-1 N	REB-1 NE	TLR 15 DS
HCTB/4-400	TS	TK-1	SQA	HIG-2	REB-2.5 N	REB-2.5 NE	TLR 25 DS
HCTB/4-450	TS	TK-1	SQA	HIG-2	REB-2.5 N	REB-2.5 NE	TLR 25 DS
HCTB/4-500	TS	TK-1	SQA	HIG-2	-	REB-5	-
HCTB/4-560	TS + DILM 7-10	TK-1 + DILM 7-10	SQA + DILM 7-10	HIG-2 + DILM 7-10	-	-	-
HCTB/4-630	TS + DILM 9	TK-1 + DILM 9	SQA + DILM 9	HIG-2 + DILM 9	-	-	-
HCTB/6-450	TS + DILM 7-10	TK-1 + DILM 7-10	SQA + DILM 7-10	HIG-2 + DILM 7-10	REB-2.5 N	REB-2.5 NE	TLR 15 DS
HCTB/6-500	TS	TK-1	SQA	HIG-2	REB-2.5 N	REB-2.5 NE	TLR 15 DS
HCTB/6-560	TS	TK-1	SQA	HIG-2	REB-2.5 N	REB-2.5 NE	TLR 25 DS
HCTB/6-630	TS	TK-1	SQA	HIG-2	REB-2.5 N	REB-2.5 NE	TLR 25 DS
HCTT/4-315	TS + DILM 7-10	TK-1 + DILM 7-10	SQA + DILM 7-10	HIG-2 + DILM 7-10	-	-	-
HCTT/4-355	TS + DILM 7-10	TK-1 + DILM 7-10	SQA + DILM 7-10	HIG-2 + DILM 7-10	-	-	-
HCTT/4-400	TS + DILM 7-10	TK-1 + DILM 7-10	SQA + DILM 7-10	HIG-2 + DILM 7-10	-	-	-
HCTT/4-450	TS + DILM 7-10	TK-1 + DILM 7-10	SQA + DILM 7-10	HIG-2 + DILM 7-10	-	-	-
HCTT/4-500	TS + DILM 7-10	TK-1 + DILM 7-10	SQA + DILM 7-10	HIG-2 + DILM 7-10	-	-	-
HCTT/4-560	TS + DILM 7-10	TK-1 + DILM 7-10	SQA + DILM 7-10	HIG-2 + DILM 7-10	-	-	-
HCTT/4-630	TS + DILM 7-10	TK-1 + DILM 7-10	SQA + DILM 7-10	HIG-2 + DILM 7-10	-	-	-
HCTT/4-710	TS + DILM 7-10	TK-1 + DILM 7-10	SQA + DILM 7-10	HIG-2 + DILM 7-10	-	-	-
HCTT/4-800	TS + DILM 9-10	TK-1 + DILM 9-10	SQA + DILM 9-10	HIG-2 + DILM 9-10	-	-	-
HCTT/4-900	TS + DILM 12-10	TK-1 + DILM 12-10	SQA + DILM 12-10	HIG-2 + DILM 12-10	-	-	-
HCTT/4-1000	TS + DILM 15-10	TK-1 + DILM 15-10	SQA + DILM 15-10	HIG-2 + DILM 15-10	-	-	-
HCTT/6-450	TS + DILM 7-10	TK-1 + DILM 7-10	SQA + DILM 7-10	HIG-2 + DILM 7-10	-	-	-
HCTT/6-500	TS + DILM 7-10	TK-1 + DILM 7-10	SQA + DILM 7-10	HIG-2 + DILM 7-10	-	-	-
HCTT/6-560	TS + DILM 7-10	TK-1 + DILM 7-10	SQA + DILM 7-10	HIG-2 + DILM 7-10	-	-	-
HCTT/6-630	TS + DILM 7-10	TK-1 + DILM 7-10	SQA + DILM 7-10	HIG-2 + DILM 7-10	-	-	-
HCTT/6-710	TS + DILM 7-10	TK-1 + DILM 7-10	SQA + DILM 7-10	HIG-2 + DILM 7-10	-	-	-
HCTT/6-800	TS + DILM 7-10	TK-1 + DILM 7-10	SQA + DILM 7-10	HIG-2 + DILM 7-10	-	-	-
HCTT/6-900	TS + DILM 7-10	TK-1 + DILM 7-10	SQA + DILM 7-10	HIG-2 + DILM 7-10	-	-	-
HCTT/6-1000	TS + DILM 7-10	TK-1 + DILM 7-10	SQA + DILM 7-10	HIG-2 + DILM 7-10	-	-	-
HCTT/8-710	TS + DILM 7-10	TK-1 + DILM 7-10	SQA + DILM 7-10	HIG-2 + DILM 7-10	-	-	-
HCTT/8-800	TS + DILM 7-10	TK-1 + DILM 7-10	SQA + DILM 7-10	HIG-2 + DILM 7-10	-	-	-
HCTT/8-900	TS + DILM 7-10	TK-1 + DILM 7-10	SQA + DILM 7-10	HIG-2 + DILM 7-10	-	-	-
HCTT/8-1000	TS + DILM 7-10	TK-1 + DILM 7-10	SQA + DILM 7-10	HIG-2 + DILM 7-10	-	-	-

### Numery artykułów

DILM 7-10	91040997	DILM 15-10	91040666-42	REB-1 NE	40025020	REB-5	40025051	TLR 15 DS	40025025
DILM 9-10	91040666-40	HIG-2	40025150	REB-2.5 N	40025030	SQA	40025140	TLR 25 DS	40025045
DILM 12-10	91040666-41	REB-1 N	40025010	REB-2.5 NE	40025040	TK-1	40025330	TS	40025345

stycznik DILM str. 646	termostat TS str. 650	termostat TK-1 str. 650	czujnik SQA str. 645	higrostat HIG-2 str. 645	regulator REB str. 638	regulator TLR str. 639

## AKCESORIA ELEKTRYCZNE

Wentylator	11-stopniowy regulator tyrystorowy	2-nast. 6-bieg. regulator tyrystorowy	ERV	regulator transformatorowy			regulator transformatorowy 2-nastawowy		falownik
	IRF	RND-1		RMB	RVS	RMT	SC2	SC2A	
HCTB/4-315	IRF-900	RND-1	ERV-3	RMB-1.5	RVS-1.5	-	SC2-1-15L25	SC2A1-15L25	-
HCTB/4-355	IRF-900	RND-1	ERV-3	RMB-1.5	RVS-1.5	-	SC2-1-15L25	SC2A1-15L25	-
HCTB/4-400	IRF-900	RND-1	ERV-3	RMB-3.5	RVS-3	-	SC2-1-25L25	SC2A1-25L25	-
HCTB/4-450	IRF-900	RND-1	ERV-3	RMB-3.5	RVS-3	-	SC2-1-25L25	SC2A1-25L25	-
HCTB/4-500	IRF-900	-	ERV-3	RMB-3.5	RVS-3	-	SC2-1-35L25	SC2A1-35L25	-
HCTB/4-560	-	-	-	-	-	-	-	-	-
HCTB/4-630	-	-	-	-	-	-	-	-	-
HCTB/6-450	IRF-900	RND-1	ERV-3	RMB-1.5	RVS-1.5	-	SC2-1-15L25	SC2A1-15L25	-
HCTB/6-500	IRF-900	RND-1	ERV-3	RMB-3.5	RVS-3	-	SC2-1-25L25	SC2A1-25L25	-
HCTB/6-560	IRF-900	RND-1	ERV-3	RMB-3.5	RVS-3	-	SC2-1-25L25	SC2A1-25L25	-
HCTB/6-630	IRF-900	-	ERV-3	RMB-3.5	RVS-3	-	SC2-1-35L25	SC2A1-35L25	-
HCTT/4-315	-	-	-	-	-	RMT-1.5	-	SC2A4-15L55	L 0.4kW
HCTT/4-355	-	-	-	-	-	RMT-1.5	-	SC2A4-15L55	L 0.4kW
HCTT/4-400	-	-	-	-	-	RMT-1.5	-	SC2A4-15L55	L 0.4kW
HCTT/4-450	-	-	-	-	-	RMT-1.5	-	SC2A4-15L55	L 0.4kW
HCTT/4-500	-	-	-	-	-	RMT-2.5	-	SC2A4-25L55	L 0.75kW
HCTT/4-560	-	-	-	-	-	-	-	-	L 0.75kW
HCTT/4-630	-	-	-	-	-	-	-	-	L 1.5kW
HCTT/4-710	-	-	-	-	-	-	-	-	L 1.5kW
HCTT/4-800	-	-	-	-	-	-	-	-	L 4.0kW
HCTT/4-900	-	-	-	-	-	-	-	-	L 5.5kW
HCTT/4-1000	-	-	-	-	-	-	-	-	L 5.5kW
HCTT/6-450	-	-	-	-	-	RMT-1.5	-	SC2A4-15L55	L 0.4kW
HCTT/6-500	-	-	-	-	-	RMT-1.5	-	SC2A4-15L55	L 0.4kW
HCTT/6-560	-	-	-	-	-	RMT-1.5	-	SC2A4-15L55	L 0.4kW
HCTT/6-630	-	-	-	-	-	RMT-1.5	-	SC2A4-15L55	L 0.75kW
HCTT/6-710	-	-	-	-	-	RMT-5*	-	SC2A4-40L55*	L 1.5kW
HCTT/6-800	-	-	-	-	-	-	-	-	-
HCTT/6-900	-	-	-	-	-	-	-	-	-
HCTT/6-1000	-	-	-	-	-	-	-	-	-
HCTT/8-710	-	-	-	-	-	-	-	-	L 0.75kW
HCTT/8-800	-	-	-	-	-	-	-	-	L 0.75kW
HCTT/8-900	-	-	-	-	-	-	-	-	L 0.75kW
HCTT/8-1000	-	-	-	-	-	-	-	-	L 1.5kW

\* regulacja napięciowa dla wersji wywiewnej (typ B).

### Numery artykułów

ERV-3	40025046	L 5.5kW	40016362	RMT-8	40025120	SC2-1-35L25	40025254	SC2A4-25L55	40025272
IRF-900	40015154	RMB-1.5	40025060	RND-1	40025630	SC2A1-15L25	40025251	SC2A4-40L55	40025274
L 0.4kW	40016302	RMB-3.5	40025070	RVS-1.5	40025232	SC2A1-25L25	40025253	SC2A4-80L55	40025278
L 0.75kW	40016312	RMT-1.5	40025100	RVS-3	40025234	SC2A1-35L25	40025255		
L 1.5kW	40016322	RMT-12	40025130	SC2-1-15L25	40025250	SC2A4-110L55	40025280		
L 4.0kW	40016352	RMT-2.5	40025105	SC2-1-25L25	40025252	SC2A4-15L55	40025270		

